



 **herckē**
SERIES **7EVEN**[®]

ASSEMBLY INSTRUCTIONS

Cabinet Doors

24", 30", 54"

Assembly Instructions Overview

Please read this brief overview before assembling your Hercke Series 7even system. What follows is an outline of the order in which your assembly process needs to occur.

1

A Phillips head N0. 2 screwdriver is the only tool required to assemble Hercke® Series 7even® products. Depending on your installation requirements, other tools that may be helpful include a level, power drill and drill bits.

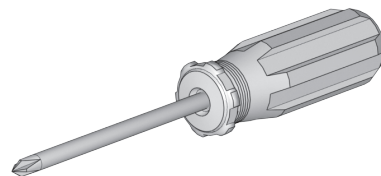

2

Assemble all platforms. Place platform in the desired location. Level each platform and make sure all platforms are level together.

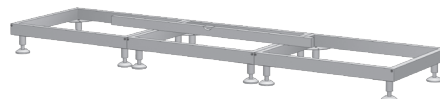

3

Pull platform out allowing yourself room to get behind the platform. Assemble cases. Stack cases and drawers on platforms in a single stack. Add Single E-Clips to the backside of cases and drawers. Slide the stack back into their final level position.

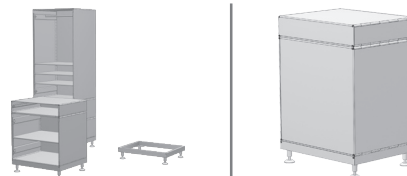

4

Assemble Overhead Storage Cases. Select overhead cabinet placement. Attach case using Wall Mount System or Channel Mount System.

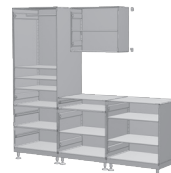

5

Fasten Single and Double E-Clips to adjoin cases and drawer modules.

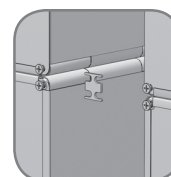

6

Snap door hinges to case hinge plates and adjust door positions.

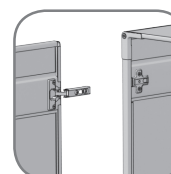
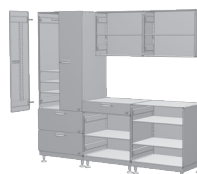

7

Attach work surface.

Chaos Defeated. Order Restored.



PARTS

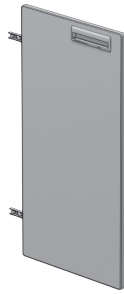

A x1 pcs
Left Door

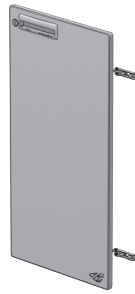

B x1 pcs
Right Door



C x2 pcs
Keys

1

- A** Hold door parallel to cabinet edge and slide the hinge **C** into the hinge plate **D** and clamp down. Repeat for bottom hinge and all other remaining doors.
- B** Close the door and inspect. If adjustments are needed go to step 2 on the back cover.

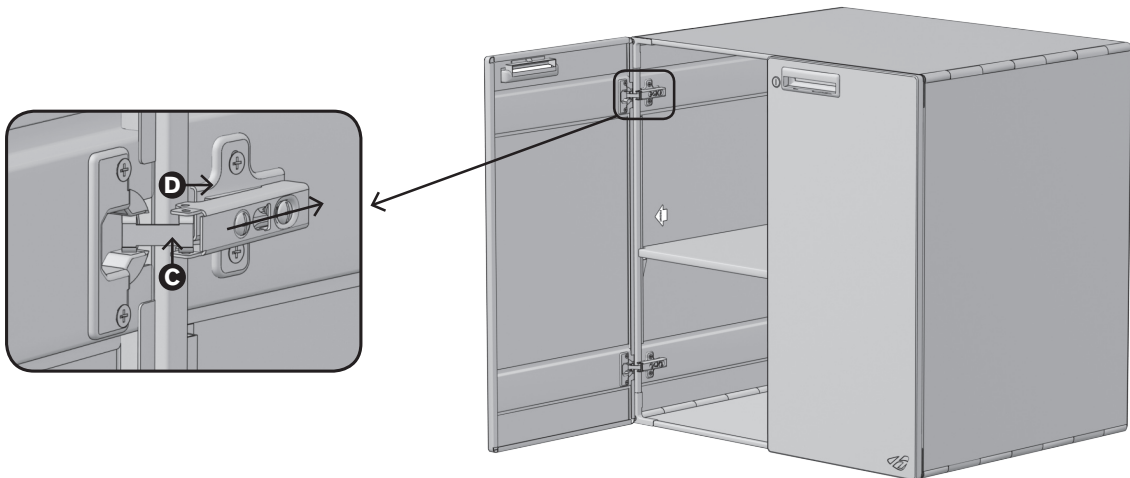

2

- A** To adjust the door's vertical position, loosen the (2) hinge plate **D** screws **E** and slide the hinge plate up or down to the desired position. Tighten both screws to lock the hinge plate in position.
- B** To adjust the door horizontal position, turn the 1st hinge **C** adjustment screw left or right to move door left or right.
- C** To adjust the door position against the case, turn the 2nd hinge **C** adjustment screw left or right to move door in or out.
- D** Close the door and inspect, readjust as necessary.

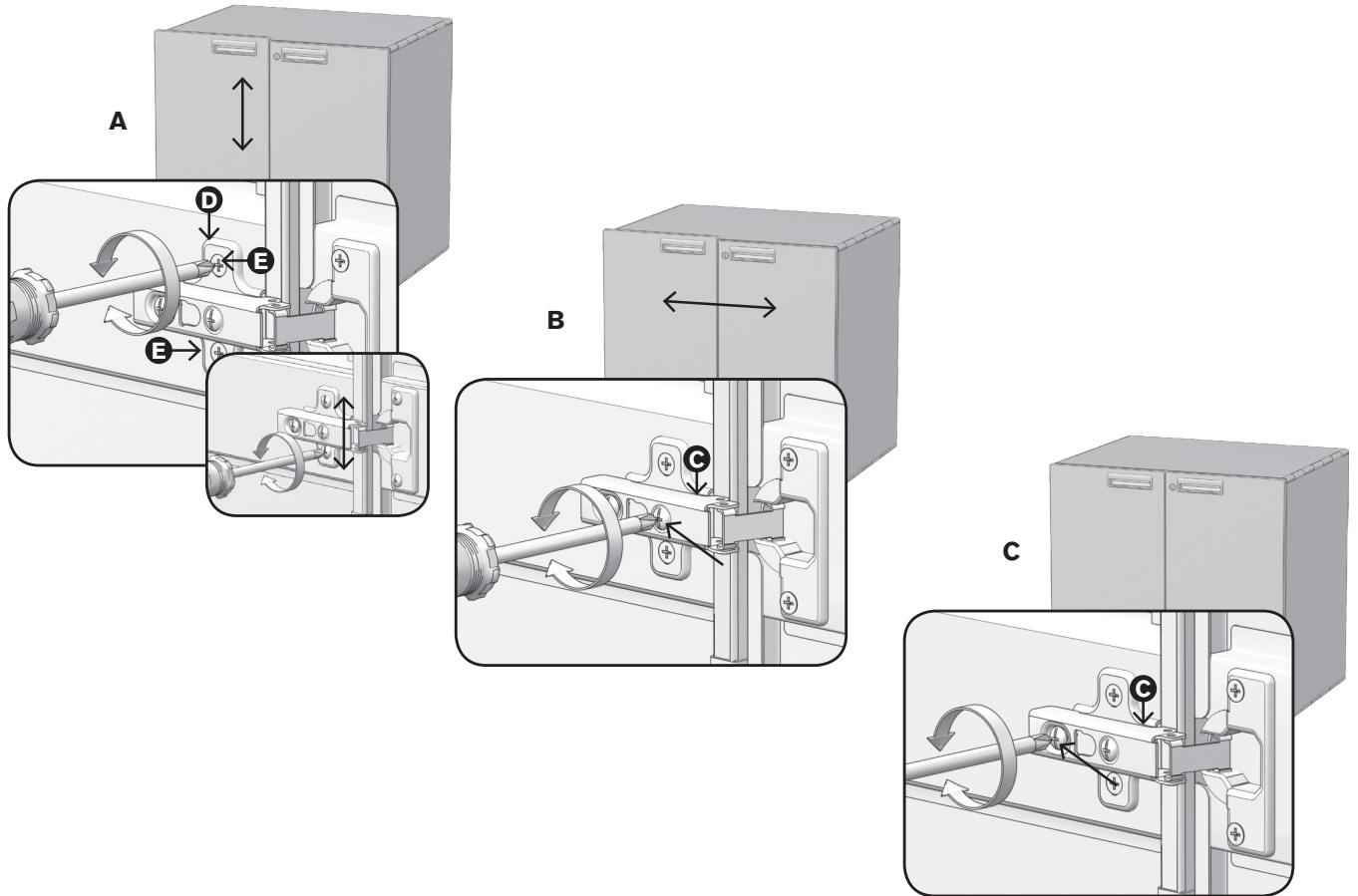

CLEANING AND CARE

Clean stainless steel surfaces using dry soft cotton cloth and stainless steel polish, buffing vertically with the line finish of the stainless steel.

Clean painted surfaces and coated surfaces using a mild dish soap and warm water solution. **DO NOT** use abrasive cleaners, glass cleaners, solvent based cleaners or furniture polish.



www.hercke.com | 855.344.2009

Please visit www.hercke.com for more information.